

# SLIDE-LOK®

## Garage & Storage Cabinets

**READ ALL INSTRUCTIONS BEFORE YOU BEGIN.  
DO NOT JUMP AHEAD OF ANY STEP.**

If this is your first time assembling a SLIDE-LOK cabinet, you may find it helpful to first assemble the cabinet without gluing to give yourself the opportunity to become familiar with the assembly process of SLIDE-LOK storage cabinets. All components will slide together without force or effort if the dovetails are lined up properly. Do not force. If force or exertion is necessary, pieces are not aligned correctly. Take apart and start over. Be sure to glue all joints at time of assembly. Allow glue to completely dry before installing.



# P2468 Pantry Cabinet

Assembly Instructions

[slide-lok.com/assembly/P2468](http://slide-lok.com/assembly/P2468)

## The Patented Dovetail Assembly System

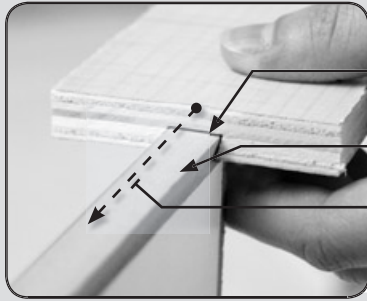

**Female Dovetail**  
Glue this edge

**Male Dovetail**

**Slide Together**  
Slide Female dovetail into Male dovetail

### Quick And Easy Assembly

All components will slide together without force or effort if the dovetails are lined up properly. If force or exertion is necessary, pieces are not aligned correctly.



**Simply Slide A Into B  
It's That Easy!**

## Step 1. - Identify all Pieces

Remove cabinet parts from box and identify all pieces as pictured in fig. 1.

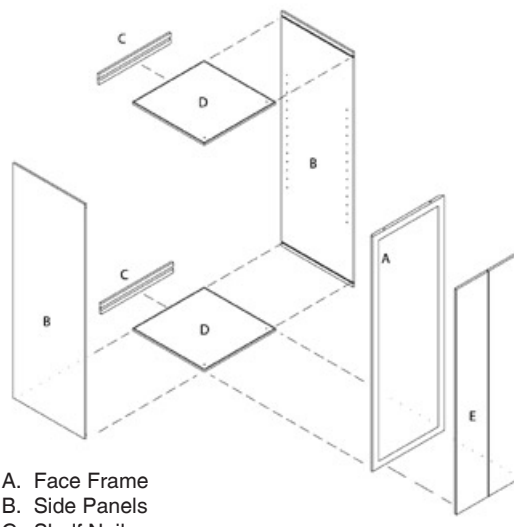
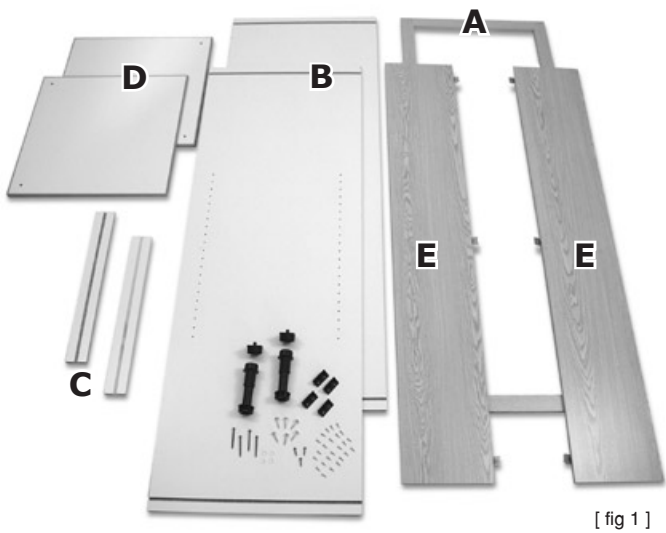

A. Face Frame  
B. Side Panels  
C. Shelf Nailers  
D. Top and Bottom Shelves.  
E. Doors

- (2) Adjustable legs & doweled tops
- (4) Clear door bumpers
- (4) Corner brackets
- (6) 1 1/2" Door screws
- (4) 2 1/2" Black installation screws
- (24) 1/2" Silver screws for adjustable Legs, corner brackets and shelf clips
- (3) 1 1/4" Black screws for joining cabinets together



## Step 2. - Attaching Top and Bottom Shelves



Place face frame "A" face down on a smooth surface to prevent scratching (you may use the box it came in). Glue all female dovetail joints as shown in fig. 2. Slide shelves "D" into position while aligning as in fig. 2A & 2B with holes closest to the face frame.

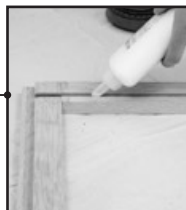

**NOTE:**  
A general purpose carpenters wood glue is recommended for assembly. Apply a 1/16" bead of glue to the entire length of the female Dovetail joint.



## Step 3. - Attaching the First Side Panel

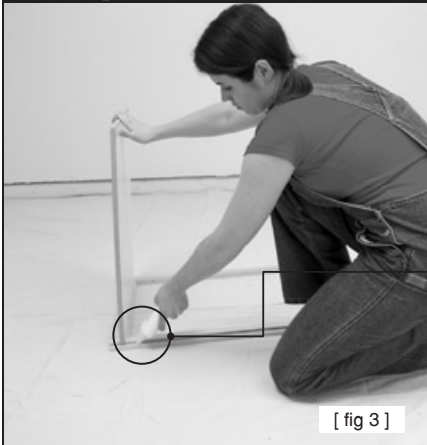

Glue rabbet joint as in fig. 3A. Dovetail joint and side panel as in fig. 3B. Slide one side panel "B" into place while aligning dovetails on top and bottom of both shelves (see fig. 3C). Make sure to start all dovetails simultaneously, then slide side panel into rabbet joint as in fig. 3D & 3E.

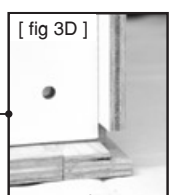
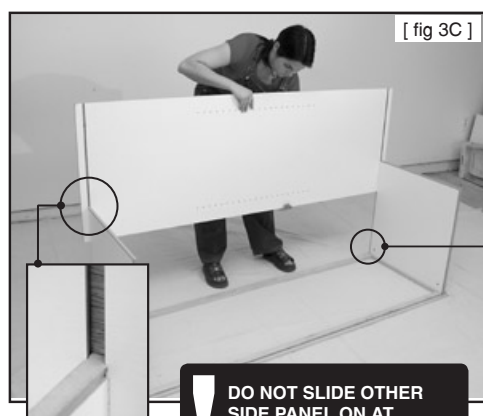
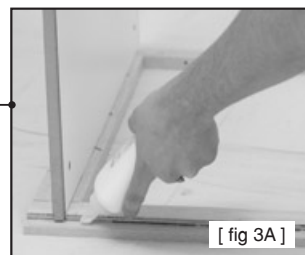

**DO NOT SLIDE OTHER SIDE PANEL ON AT THIS TIME.**

## Step 4. - Attaching Top and Bottom Nailers

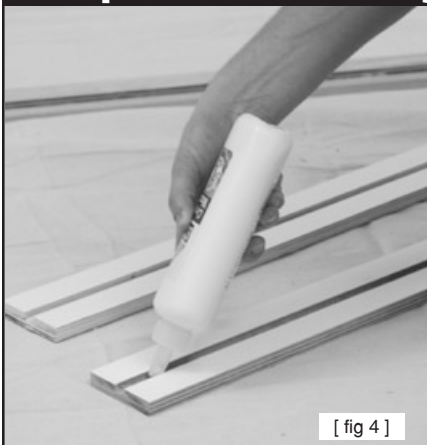

Glue the female dovetail on the nailer see fig. 4. Slide one nailer onto the top shelf (fig. 4A) and one nailer onto the bottom shelf (fig. 4B). Make sure they touch the side panel.

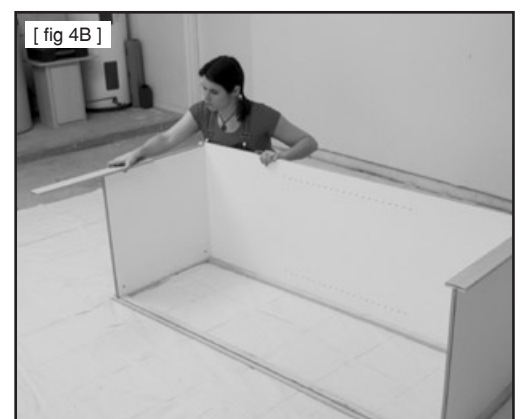

Remember to follow the steps exactly as shown. Do not jump ahead, or you'll get tangled up!

## Step 5. - Attach Second Side Panel and Installing Corner Blocks



[ fig 5 ]

Repeat step 3 for the other side panel. See figures 5 & 5a. Take the corner blocks and 1/2" screws, and attach to the face frame and side panel of cabinet, see figures 5B, 5C, & 5D. Attach 2 corner blocks to each side of the cabinet, see figure 5E.



[ fig 5A ]



[ fig 5B ]



[ fig 5C ]

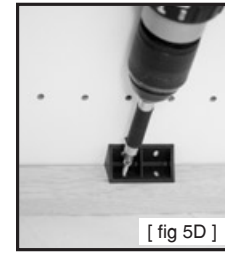

[ fig 5D ]

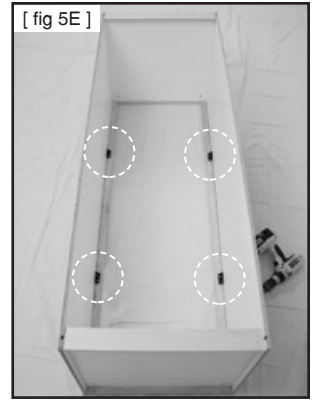

[ fig 5E ]

## Step 6. - Attaching Cabinet Legs



[ fig 6 ]

Assemble adjustable leg by attaching the dowel head to the leg (fig. 6, 6A, and 6B). Take the assembled leg and insert dowel into the hole provided as in fig. 6A. Use 1/2" screws and screw leg into bottom of cabinet to keep it firmly in place (fig. 6C and 6D). Let glue dry



[ fig 6A ]



[ fig 6B ]



[ fig 6C ]



[ fig 6D ]

Before Proceeding to the next step, let glue dry completely.

## Step 7. - Fasten Cabinet to Wall



[ fig 7 ]

After glue is dry locate studs in wall (fig. 7A). Attach cabinet to wall using 2 1/2" screws. (See fig. 7)

**NOTE:**  
It is important that the cabinet is set flush to the wall and fastened to wall studs for stability and strength.



[ fig 7A ]

## Step 8. - Hang Cabinet Doors



[ fig 8 ]

To hang doors, use the 1 1/2" silver screws. Hold door up so the door hinge hole lines up with the pre-drilled hole in the face frame. Screw in the hinge so the doors are level across the top and flush in the front. Take clear bumpers and attach as in fig. 8B, to top and bottom of doors.



[ fig 8A ]

**NOTE:**  
Hinge is 6 way adjustable (up, down, in out, back and forth) fig. 8A.

In and out  
Up and Down  
Back and Forth



[ fig 8B ]

**DO NOT TO OVERTIGHTEN!**  
It is recommended that you finish tightening with a screwdriver to avoid stripping the pre-drilled holes.

## Step 9. - Installing Optional Adjustable Shelf

If you purchased a shelf package continue with Step 9, otherwise skip this step.



[ fig 9 ]

To install shelf, use all 4 shelf clips. Push shelf clip into holes, as in fig. 9, on side panel. Make sure the clips are level in front, back and on the other side panel, see fig. 9A

Angle shelf and slide into cabinet, setting one side of shelf on top of shelf clip, see fig. 9B. Let shelf drop onto the other side and snap into place, see fig. 9C. To secure screw into underside of shelf as in Fig. 9D.

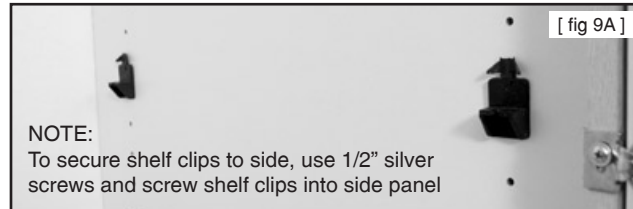

[ fig 9A ]

**NOTE:**  
To secure shelf clips to side, use 1/2" silver screws and screw shelf clips into side panel



[ fig 9B ]



[ fig 9C ]



[ fig 9D ]

## Step 10. - Congratulations!



**CONGRATULATIONS!**  
You have just finished assembling and installing a SLIDE-LOK cabinet.

**SLIDE-LOK**  
Garage & Storage Cabinets



## Design Your Own SLIDE-LOK Storage Solution

Visit Jack's Design Center, an interactive SLIDE-LOK Storage System design tool, which will enable you to design your own SLIDE-LOK Storage system online

Jack's Design Center simplifies the process of designing your own SLIDE-LOK Storage

Solution with features such as user dimensions, a parts list generator and the ability to print your SLIDE-LOK creation, making ordering your next SLIDE-LOK Storage System easier than ever.

## NOTE: - Attaching Two or More Cabinets

When putting two cabinets together, hold both face frames flush, see fig. 10A.

Take a 1 1/4" screw and insert it behind the face frame, into the side panel of one cabinet through the other cabinet's side panel, screwing it tightly together see figures 10B & 10C. Do this at the top, middle and bottom of the cabinet.

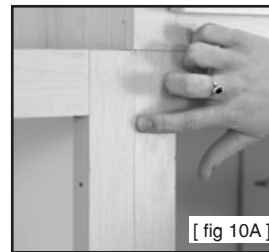

[ fig 10A ]

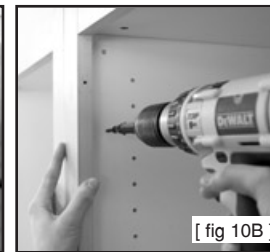

[ fig 10B ]

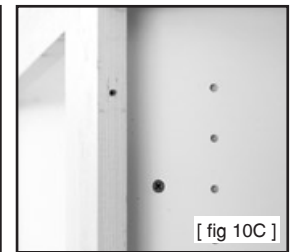

[ fig 10C ]